

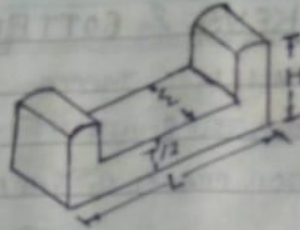

Date . . .

Mon ● Tue ● Wed ● Thu ● Fri ● Sat ● Sun ●

DOUBLE HEADED KEY

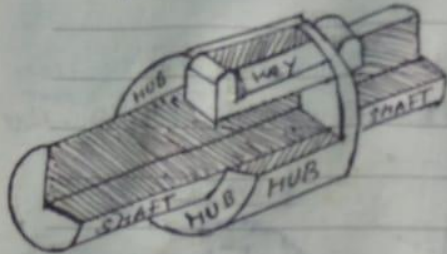

TAPER KEYS

$$L = 1.5D$$

$$W = 0.25D + 2\text{mm}$$

$$T = 0.2D + 2\text{mm}$$

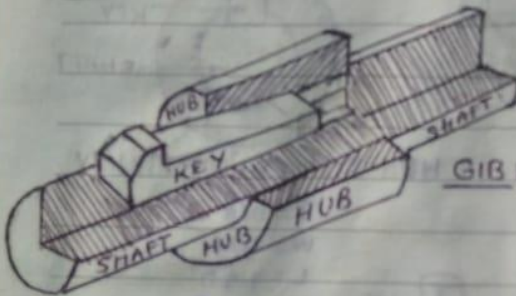

GIB HEAD KEY

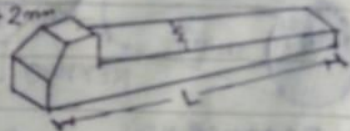

TAPER 1:100

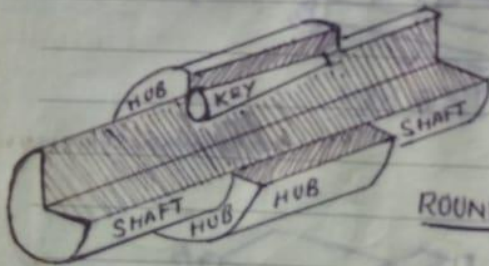

$$d = 0.2D$$

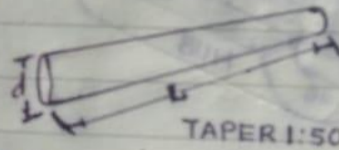

TAPER 1:50

ROUND TAPER KEY

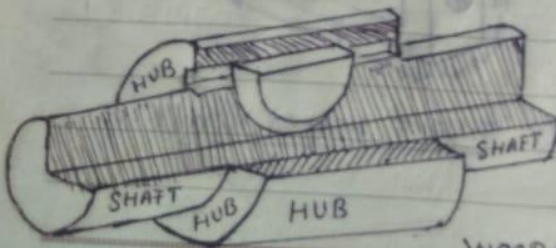

$$T = \frac{D}{6}$$

$$R = \frac{D}{3}$$

$$= 2T$$



WOODRUFF KEY



# KEYS & COTTERS

Keys - ① PARALLEL ② TAPPER

SUNK KEYS - HUB & SHAFT में KEYWAY में फिट होकर जोड़ने के लिये प्रयुक्त होते हैं।

① FEATHER KEY OR PRALLEL ② GIB HEAD KEY ③ WOODRUFF KEY ④ Round Key

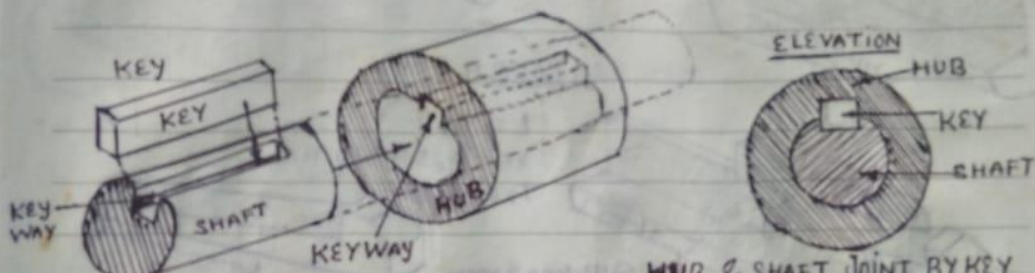

HUB & SHAFT JOINT BY KEY

$$T = D/6$$

$$W = D/4$$

$$L = 1.5D$$

$$H = H + \frac{T}{2} = 1.75D$$

FEATHER KEYS

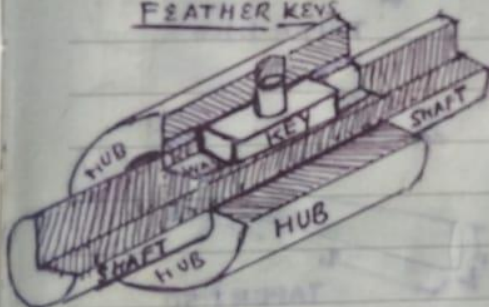

① PEG KEY

$$T = \text{HUB KEYWAY} + \text{SHAFT KEY}$$

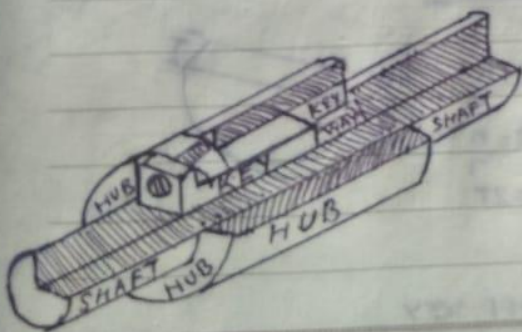

② SINGLE HEADED KEY





SOLID OR FLAT SADDLE KEY

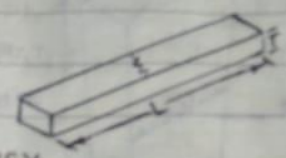

HOLLOW SADDLE KEY

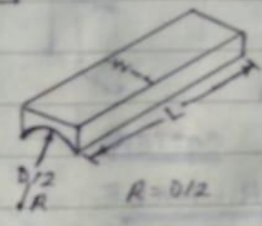

SPLINE HUB

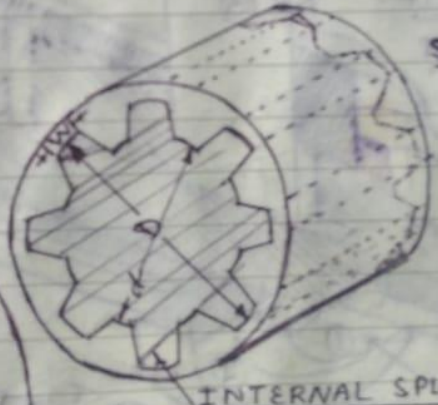

INTERNAL SPLINE

SPLINE SHAFT



EXTERNAL SPLINE

<u>MACHINE PINS</u>	
BOWEN PIN (ROUND)	Radial locking pins
TAPER PIN (KNUCKLE)	1. GROOVED PIN
CLEVIS PIN (KNUCKLE)	2. SPRING PIN
SPLIT PIN	

UPPER HALF SECTION  
OF GIB & COTTER  
JOINT

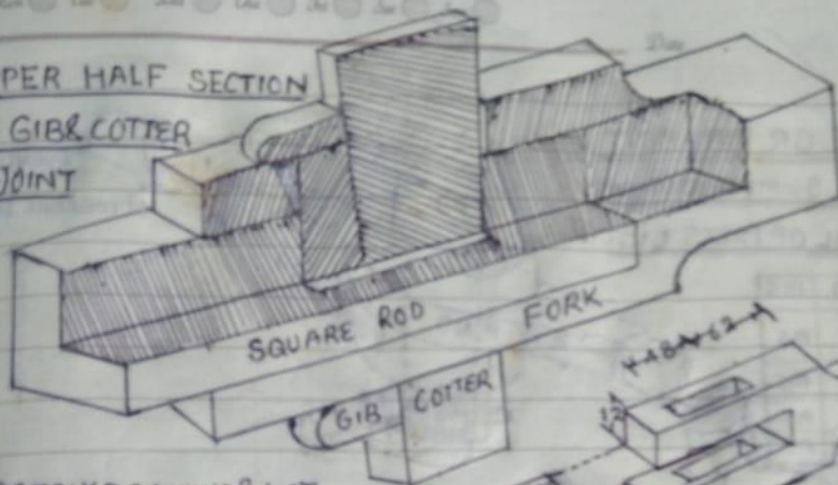

ASSEMBLY DRAWING & LIST

- ① SQUARE ROD M.S.
- ② FORK M.S.
- ③ GIB & COTTER C.I.

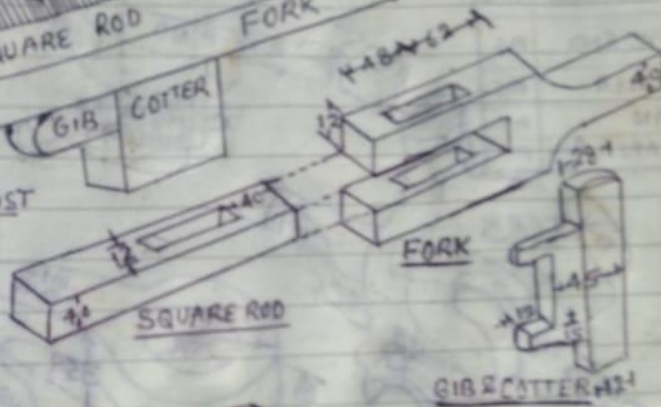

HALF SECTION OF  
SLEEVE & COTTER  
JOINT

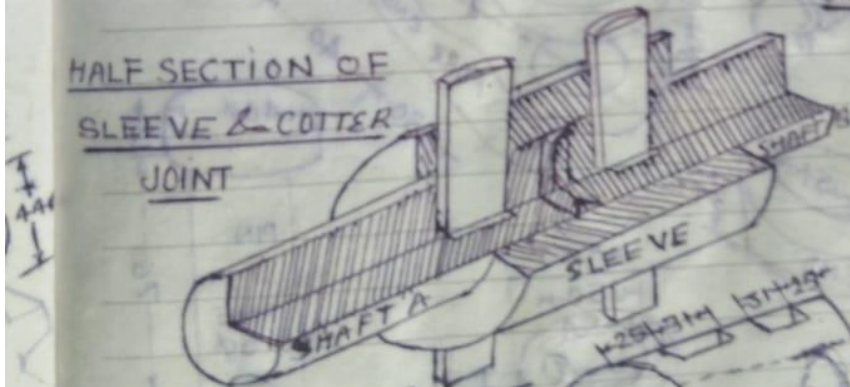

ASSEMBLY

- ① SLEEVE M.S.
- ② SHAFT A & B
- ③ COTTER M.S.

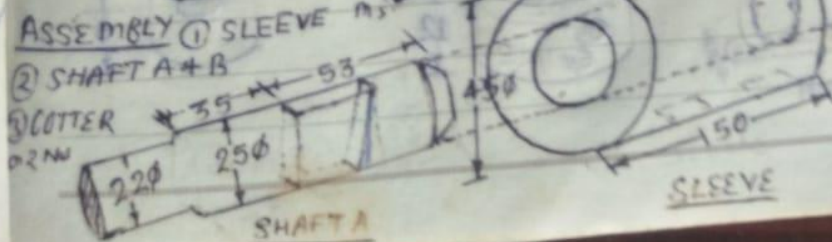





Date

# KNUCKLE OR PIN JOINT

## ASSEMBLED ISOMETRIC VIEWS AND DETAIL OF PARTS LIST

1	FORK END	M.S
2	EYE END	M.S
3	COLLER	M.S
4	PIN	M.S
5	TAPER PIN	M.S

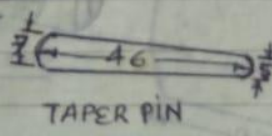
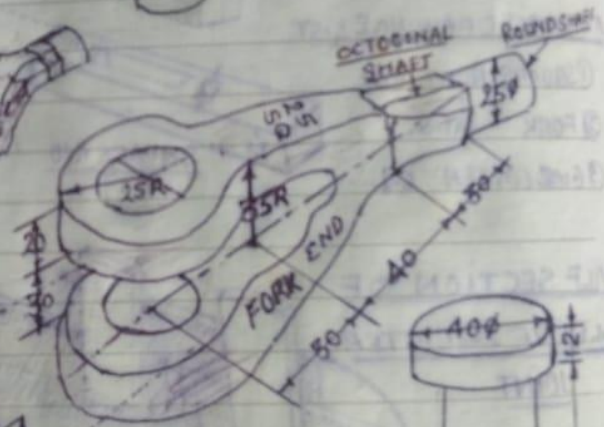
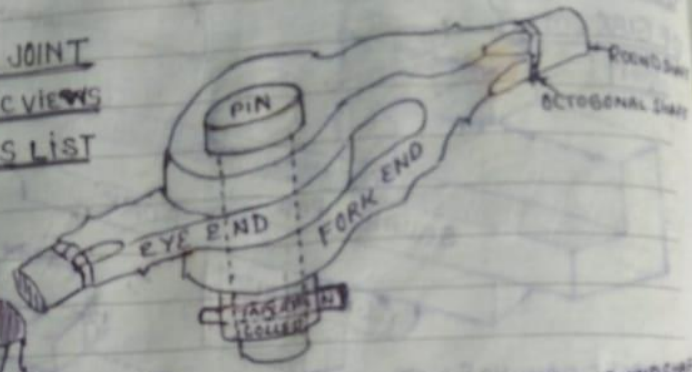

3/3/22

A. K. RAO



Date

Mon Tue Wed Thu Fri Sat Sun

# COTTER-JOINT

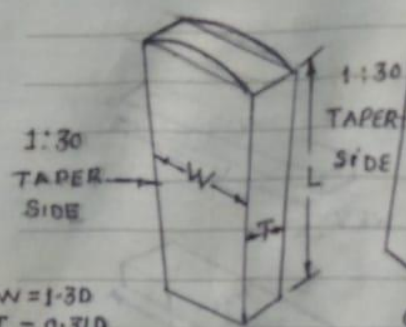

$W = 1.3D$   
 $T = 0.31D$

COTTER

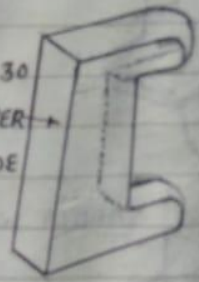

GIB



UPPER HALF SECTION OF SOCKET & SPIGOT JOINT

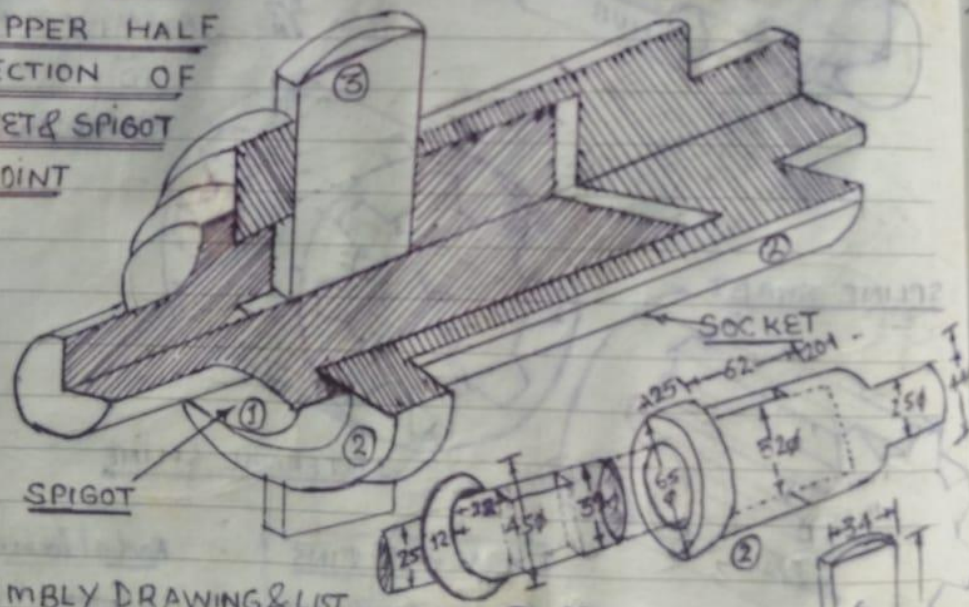

ASSEMBLY DRAWING & LIST

①	SPIGOT	MS.
②	SOCKET	MS.
③	COTTER	C.I.

UPPER  
OF G  
JOINT

ASSEMBLY  
① SPIGOT  
② SOCKET  
③ COTTER

HALF  
SECTION

ASSEMBLY  
② SOCKET  
③ COTTER